



Engineered Honeycomb  
Solutions and Services

# Honeycomb Panels



PLASCORE®

# Plascore Honeycomb Panels

Light, Strong, Tough, Cost-Effective

Plascore Honeycomb Panels are a high-strength, lightweight material that provide efficient mechanical performance. Our lightweight panels are an excellent alternative to monolithic materials (e.g., solid aluminum, wood and steel) as well as panels with traditional core materials such as plywood, balsa, and foam.

Available in a wide range of sheet sizes and facings, our honeycomb panels are designed for ease of use in many common applications and processes. They can be engineered to meet specific requirements for strength and stiffness. Plascore Honeycomb Panels are used in many situations that require elevated core shear, compression and adhesion performance.

- **Lightweight**
- **Strong**
- **Tough**
- **Stable**
- **Easy-to-Use**
- **Value Engineered / Cost-effective**
- **Moisture and Corrosion Resistant**

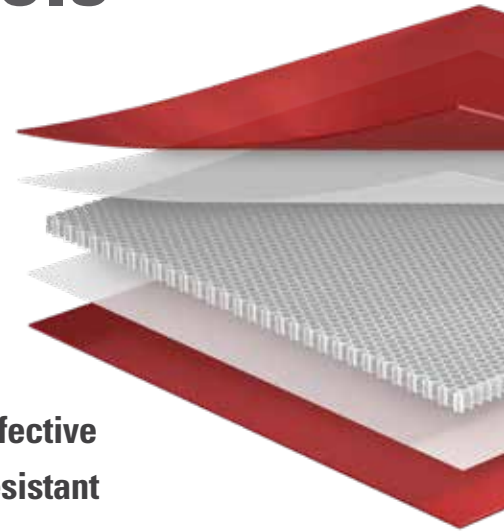

## A World of Applications



### Building Products

Plascore Honeycomb Panels provide a flat, stiff, stable structure for use in building as a backing material to metal, glass, stone, and other decorative surfaces. Uses include wall cladding, ceilings, canopies, and elevator interiors.

### Commercial

Plascore Honeycomb Panels offer elevated mechanical properties; moisture, chemical and impact resistance; as well as vibration dampening. The result is improved performance in doors, platforms, fixtures, and custom furniture among others.

### Ground Transportation

Plascore Honeycomb Panels provide a lightweight solution for use in rail, automotive, truck, trailer, recreational vehicles, racing, and also military and specialty vehicles. Applications include walls, doors, floors, ramps, ceilings, bulkheads, seating, and shelves.

### Marine & Recreation

Plascore Honeycomb Panels offer a high strength-to-weight ratio that satisfies the demands of many applications. Sporting goods, boat decks, partitions, hatches, and doors are just a few examples.

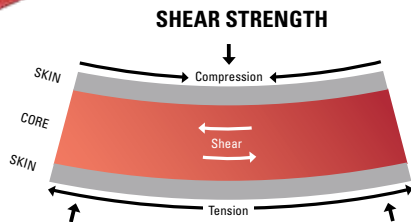
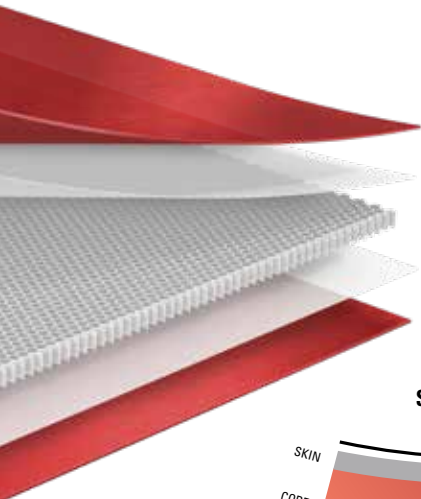

**RELATIVE STIFFNESS**

THICKNESS	1T	4T	8T
STIFFNESS	1	40	185
WEIGHT	1	1.25	1.33

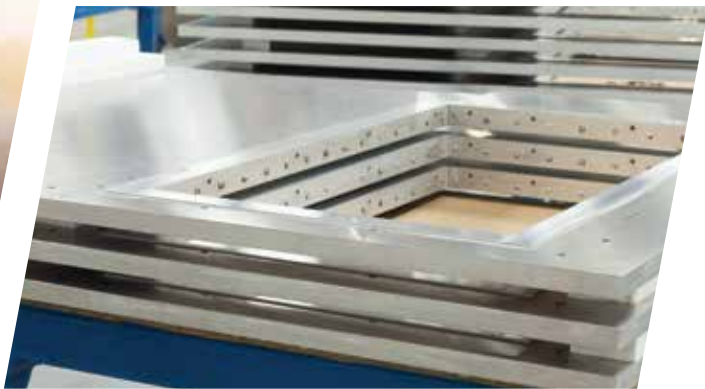

## Special Characteristics of Custom Panels

- High strength-to-weight ratio
- Energy absorbing
- Any color
- Non-metallic options
- Non-porous options
- Primed for painting or powder coating
- Fungi, rot, and moisture resistant
- Internal structures such as reinforcement bars or channels
- Finished edges for decorative, mechanical or structural purposes
- Hard points within the panel to allow use of standard fasteners

## What is a Honeycomb Panel?

Two high-modulus and high-strength face sheets are adhesively bonded to Plascore Honeycomb. The result is a high-strength, lightweight structure that behaves much like an I-Beam.

## What Impacts Panel Stiffness?

Bending stiffness is primarily based on three panel characteristics:

1. Face Sheet Thickness
2. Face Sheet Modulus of Elasticity
3. Overall Panel Thickness

In simple terms, the core increases the flexural rigidity of a sandwich panel by effectively increasing the distance between the two stress skins, much like an I-beam. Honeycomb cores also provide shear resistance, a component to overall flexural rigidity.

## Stiffer, Stronger, and Lighter

The stiffness of Plascore Honeycomb Panels allows the end user to utilize less material and reduce weight. Stiffness increases exponentially compared to single sheet material. The use of honeycomb core creates a dramatic increase in stiffness with very little weight gain.

Plascore engineers can work with your team to provide a panel that meets your requirements. We offer custom manufacturing, along with design, test and prototyping assistance to build you a composite sandwich structure.

## What Factors Influence Design?

Three factors are critical to meet your structural needs:

1. Loading Conditions
2. Support Structures
3. Maximum Deflection Allowed

Additional design criteria such as type of skin material, target cost, flammability, thickness limitations, operating environment, and weight, will help define the appropriate panel construction for your application.

## What Capabilities Does Plascore Offer?

- Metal Welding
- Adhesive Bonding
- CNC Machining
- Insert Installation
- Surface Treatment
- Assembly
- Powder Coat Paint
- QC Testing
- Closed Edges

# Typical Panel Options

## Skin Materials:

- Aluminum
- Stainless Steel
- High Pressure Laminate
- Glass/Epoxy Prepreg
- G10 Fiberglass
- For other materials, please contact us.



## Skin Finishes:

- Clear Epoxy Primer
- Mill Finish
- Bond and/or Paint Ready
- Decorative
- Powder Coat
- For other finishes, please contact us.



## Honeycomb Cores:

- Aluminum (Commercial and Aero/Military Grade)
- Stainless Steel
- Nomex® (Commercial and Aero/Military Grade)
- Kevlar® (Aero/Military Grade)
- Polypropylene
- Polycarbonate

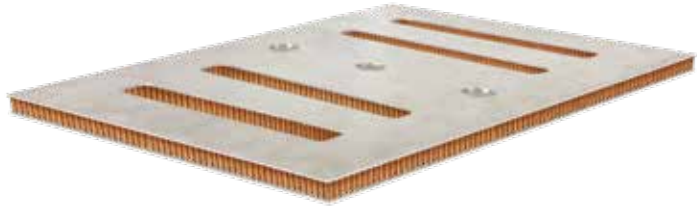

## Adhesives:

- Commercial grade toughened epoxy
  - Cost-effective
  - Service Temperatures up to 180°F.
- Modified Epoxy Film Adhesive
  - Service Temperature options up to 400°F.
  - Multiple weights available
  - Can be MIL spec or ASTM certified
- Other adhesive types available by request.



## Sizes:

- Thickness: 1/8"– 3" standard
- Width: 48" and 60" standard
- Length: Up to 190" standard
- For all other sizes, please contact us.



These are all standard options. Please contact your Plascore Sales Representative to ask about all other options.





## Panel Construction Considerations—Fabricating

Machining/cutting can be done in most cases with basic wood working equipment such as a table saw, band saw, or router and carbide tipped tooling.

**DO NOT USE ANYTHING WITH A RECIPROCATING BLADE!**



## Co-Fabricated Edge Close-outs

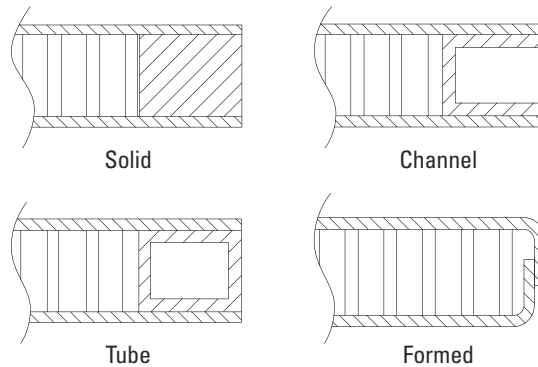

## Post-Fabricated Edge Close-outs

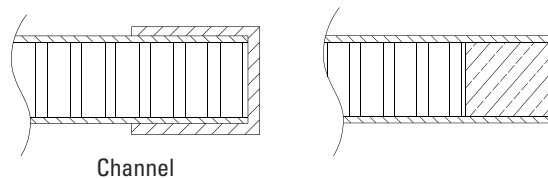

## Blind Fastening

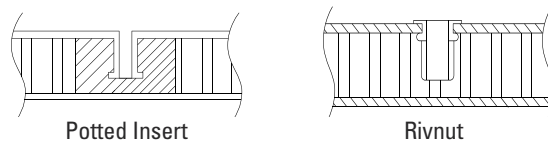

## Thru Fastening

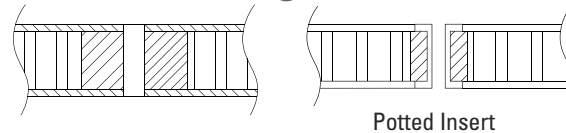

## Other Panel Construction Considerations—Joining

Panel Joining can present a solution when a panel is too large to laminate in one piece.

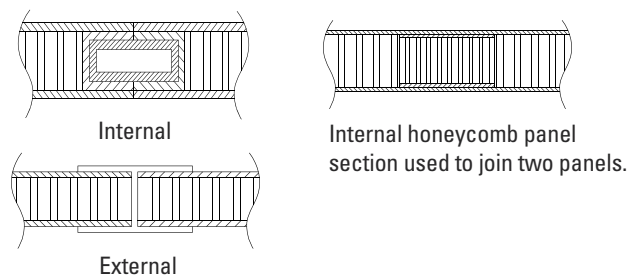

# Technical Data

Designed to add value in OEM Product manufacturing, Plascore Honeycomb Panels are available cut to a custom size or shape, or in a standard sheet size of 48" x 96" in varying thicknesses.

Note that all of these are open edge.



**PP4.0-86** PP Honeycomb core 4.0 pcf with 0.106" Luan Plywood skin

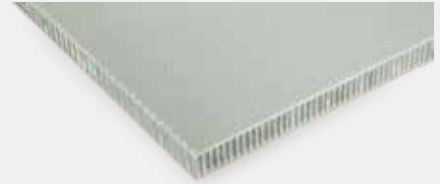

**AA5.2-95** Aluminium Honeycomb core 5.2 pcf with 0.015" Glass-Epoxy skin

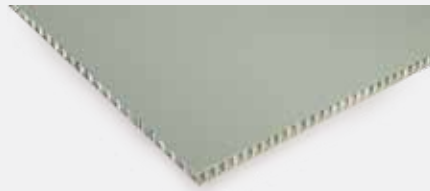

**AA3.6-80** Aluminium Honeycomb core 3.6 pcf with 0.020" Aluminium skin



**PP5.0-90** PP Honeycomb core 5.0 pcf with 0.014" Glass-Epoxy with Peel Ply film skin

## Specifications

PANEL ID	SKIN	CORE	ADHESIVE	FLATWISE TENSILE STRENGTH <sup>1</sup>		CLIMBING DRUM <sup>2</sup> (PER UNIT WIDTH)	
				lb/in <sup>2</sup>	N/mm <sup>2</sup>	lbf	N
AA3.6-80	.020" Aluminum with Epoxy Primer	3/8" Aluminum 3.6#pcf	Commercial Grade Toughened	644	4.44	52	231
AA5.2-95	.015" Fiberglass Prepreg	1/4" Aluminum 5.2#pcf	Epoxy	998	6.88	92	407
PP4.0-86	.106" Luan Plywood	.394" Polypropylene 4.0#pcf	Commercial Grade Toughened	140	0.96	NA	NA
PP5.0-90	.014" G10 Fiberglass	.315" Polypropylene 5.0#pcf	Commercial Grade Toughened	89	0.62	22	98
PLYWOOD	-	-	-	-	-	-	-



## Characteristics

PANEL ID	AA3.6-80	AA5.2-95	PP4.0-86	PP5.0-90	PLYWOOD
HIGH STRENGTH	X	X	X	X	X
STIFF	X	X	X	X	X
LOW FLAMMABILITY	X				
FINISHING	X	X			
SALT ENVIRONMENT		X	X	X	
FUEL ENVIRONMENT		X	X	X	
PAINTABLE	X	X		X	X
CHEMICAL RESISTANCE*				X	
LIGHTWEIGHT	X	X	X	X	
MACHINABLE	X	X	X	X	X

\* Detailed performance available upon request.

STABILIZED COMPRESSIVE STRENGTH <sup>3</sup>		THICKNESS		WEIGHT		FLEXURAL RIGIDITY <sup>4</sup> (PER UNIT WIDTH)	
lb/in <sup>2</sup>	N/mm <sup>2</sup>	in	mm	lb/ft <sup>2</sup>	kg/m <sup>2</sup>	lb-in <sup>2</sup>	N-mm <sup>2</sup>
369	2.54	0.25	6	0.79	3.9	5375	1.46
		0.50	13	0.84	4.1	23291	6.32
		0.75	19	0.94	4.6	46858	12.72
		1.00	25	1.01	4.9	71654	19.45
749	5.16	0.25	6	0.53	2.6	1673	0.45
		0.50	13	0.62	3.0	7756	2.11
		0.75	19	0.72	3.5	17776	4.83
		1.00	25	0.82	4.0	30231	8.21
184	1.27	0.50	13	1.04	5.1	5585	1.52
		0.75	19	1.12	5.5	13110	3.56
		1.00	25	1.20	5.9	20388	5.53
287	1.98	0.50	13	0.57	2.8	6259	1.70
		0.75	19	0.67	3.3	13015	3.53
		1.00	25	0.76	3.7	20117	5.46
-	-	0.50	13	1.56	7.6	12947	3.51
		0.75	19	2.34	11.4	55506	15.07

<sup>1</sup> Data obtained through testing in accordance with ASTM C 297

<sup>2</sup> Data obtained through testing in accordance with ASTM D 1781 with specimen widths of 3"

<sup>3</sup> Data obtained through testing in accordance with ASTM C 365

<sup>4</sup> Data obtained through testing in accordance with ASTM C393/C 393M-06 at a Four-Point, Quarter-Point Loading configuration and a space of 20", width 3", except 0.25"T @ 1.5" width

## World Class Honeycomb Manufacturing, Technical Support and Service

Plascore, Inc. is an ISO-9001 global manufacturer of Honeycomb cores and composite panels. In addition to our proprietary Honeycomb manufacturing process, our value-added capabilities include adhesive development, CNC machining, powder coating, welding, thermoset and thermoplastic laminating and assembly.

We are dedicated to manufacturing competitive products with superior performance and on-time delivery. Plascore Honeycomb products are engineered to help reduce material and manufacturing costs, while making the end product lighter, stiffer, stronger. Wherever there's a need for greater structural strength with less weight, you'll find Plascore Honeycomb cores and technology.

You can rely on Plascore regional sales managers, engineers and in-house service representatives to provide prompt professional attention to your needs. From project inception through delivery and installation, our goal is to ensure your complete satisfaction. We're here to answer your questions regarding technical specifications, performance and application.

For further information, visit [www.plascore.com](http://www.plascore.com).



### Corporate Headquarters

**Plascore Incorporated**  
615 N. Fairview St.  
Zeeland, MI 49464-0170  
USA

Phone (616) 772-1220  
Toll Free (800) 630-9257  
Fax (616) 772-1289  
Web [www.plascore.com](http://www.plascore.com)  
Email [panels@plascore.com](mailto:panels@plascore.com)

### Europe

**Plascore GmbH&CoKG**  
Feldborn 6  
D-55444 Waldlaubersheim  
Germany

Phone +49(0) 6707-9143 0  
Fax +49(0) 6707-9143 0  
Web [www.plascore.de](http://www.plascore.de)  
Email [sales.europe@plascore.de](mailto:sales.europe@plascore.de)



Plascore, Inc., employs a quality management system that is AS9100, ISO 9001 and ISO 14001 certified.

**IMPORTANT NOTICE:** The information contained in these materials regarding Plascore's products, processes, or equipment, is intended to be up to date, accurate, and complete. However, Plascore cannot warrant that this is always the case. Accordingly, it is a purchaser's or user's responsibility to perform sufficient testing and evaluation to determine the suitability of Plascore's products for a particular purpose. Information in these materials and product specifications does not constitute an offer to sell. Your submission of an order to Plascore constitutes an offer to purchase which, if accepted by Plascore, shall be subject to Plascore's terms and conditions of sale. PLASCORE MAKES NO WARRANTIES OF ANY KIND REGARDING THESE MATERIALS OR INFORMATION, EITHER EXPRESS OR IMPLIED, INCLUDING WITHOUT LIMITATION THE IMPLIED WARRANTIES OF MERCHANTABILITY AND FITNESS FOR A PARTICULAR PURPOSE. Plascore owns and shall retain all worldwide rights in its intellectual property, and any other trademarks used in these materials are the property of their respective owners. The information in these materials shall not be construed as an inducement, permission, or recommendation to infringe any patent or other intellectual property rights of any third parties. © 2021 Plascore, Inc. All Rights Reserved. v4.6.2021

